



YBL 系列离心机用隔爆型三相异步电动机
(机座号 160~200)

(工厂用: 防爆标志 Ex db II B T4 Gb)

YBL series Flameproof Three Phase
Asynchronous Motor for Centrifuge
(Frame 160~200)

(Factory: Marking Ex db II B T4 Gb)

使用说明书

Operation Manual

安徽皖南电机股份有限公司

Anhui Wannan Electric Machine Co.,Ltd

衷心感谢您选购、使用皖南电机。

在使用电动机之前，请扫码仔细阅读本说明书，以便您正确的使用和维护。

1 产品概述

我公司生产的YBL系列离心机用隔爆型三相异步电动机是全封闭、外扇冷、鼠笼型三相异步电动机，按照 GB/T 3836.1-2021《爆炸性环境用电气设备第1部分通用要求》和 GB/T3836.2-2021《爆炸性环境用电气设备第2部分：由隔爆外壳“d”保护的的设备》的要求，制成隔爆型。其防爆标志为 Ex db II AT4、Ex db II BT4。产品适用于工厂（Ex db II AT4、Ex db II BT4）含有II类A、B级T1~T4组可燃性气体或蒸汽与空气形成的爆炸性混合物的场所。该系列电动机作为制药厂高速离心机配套设备的产品，采用高启动转矩设计，具有高转矩、低噪声、体积小、承载大、安装方便等特点。

执行标准：Q/WN.263—2022《YBL系列离心机用隔爆型三相异步电动机（机座号160-200）》

2 产品型号及名称

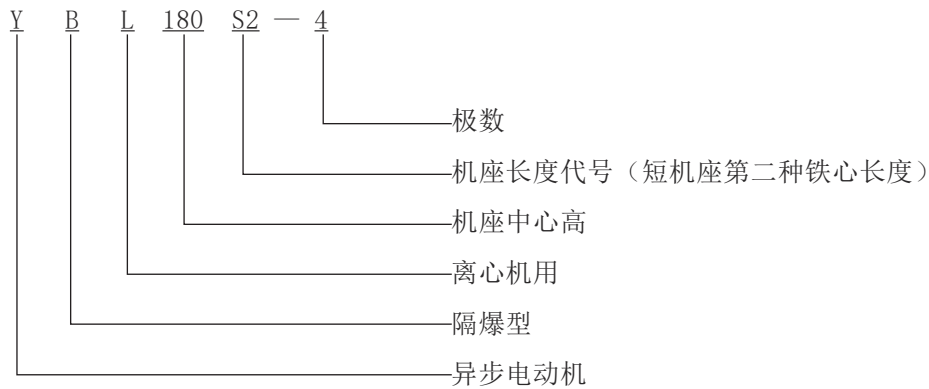

3 使用范围及使用条件

3.1 适用常见可燃性气体、蒸汽级别、温度组别举例见表1。

表 1

级 别	引燃温度组别			
	T1	T2	T3	T4
IIA	甲烷、乙烷、丙烷、 苯乙烯、甲苯、二甲 苯、一氧化碳、醋酸	丁烷、丙烷、乙苯、 甲醇、乙醇、丙醇、 本醇	戊烷、己烷、庚烷、 辛烷、癸烷、环己烷 煤油、柴油、汽油	
IIB	丙炔、环丙烷、 焦炉煤气	乙烯、1.3丁二烯环 氧乙烷、1.2一环 氧丙烷	二甲醚、丙烯醛、 甲氢糠醇四氢呋喃、 硫化氢	乙基甲基醚 二乙醚 四氟乙烯

3.2 运行使用条件

- 3.2.1 海拔不超过 1000m。
- 3.2.2 环境空气温度随季节而变化，但最高不超过 40℃，最低为 -15℃。
- 3.2.3 环境空气最大相对湿度为 90%，同时该月月平均最低温度不高于 25℃。
- 3.2.4 电动机额定电压为 380V，额定频率为 50Hz，绝缘等级为 F 级。
- 3.2.5 电动机的定额是以连续工作制（S1）为基准的连续定额，允许满压起动。
- 3.2.6 电动机外壳最高表面温度（温度计法）在规定允许最不利的工作条件下应不超过 130℃。
- 3.2.7 电动机运行时，电源、电压和频率额定值的偏差按 GB 755 的规定。

4 电动机的主要技术参数及安装结构型式

4.1 主要技术参数见表 2

表 2

型号	额定功率 kW	额定电压 V	额定电流 A	额定频率 Hz	额定转速 r/min	效率 %	功率因数 COSΦ
YBL160S1-2	2.2	380	4.8	50	2900	85.0	0.82
YBL160S2-2	3.0	380	6.5	50	2890	85.0	0.82
YBL160S1-4	1.5	380	3.9	50	1445	84.0	0.70
YBL160S2-4	2.2	380	5.5	50	1440	84.0	0.73
YBL160S3-4	3.0	380	7.1	50	1440	85.0	0.76
YBL160S4-4	4.0	380	9.2	50	1430	85.0	0.78
YBL180S-2	4.0	380	8.5	50	2917	87.0	0.82
YBL180S1-4	5.5	380	11.5	50	1415	86.0	0.85
YBL180S2-4	7.5	380	16.2	50	1410	84.0	0.86
YBL180S3-4	11	380	22.3	50	1410	85.0	0.88
YBL180S-6	7.5	380	16.8	50	945	84.0	0.81
YBL200M1-4	11	380	22.6	50	1445	89.0	0.83
YBL200M2-4	15	380	31.0	50	1440	89.0	0.83
YBL200S-6	7.5	380	16.7	50	960	84.0	0.81
YBL200M1-6	11	380	22.6	50	950	87.0	0.85
YBL200M2-6	15	380	32.7	50	905	84.0	0.83
YBL200L1-6	18.5	380	39.9	50	920	82.0	0.87
YBL200L2-6	22	380	46.6	50	920	82.5	0.87

4.2 电动机的安装结构型式为 IMV16。

5 主要结构

5.1 电动机的接线盒位于电动机顶部，制成三个线端子。适用于橡胶套电缆（或塑料电缆）和钢管布线的两种结构，内设一个接地端子，并按其需要分别制成一个（小 M5）出线口。在接线盒座与接线盒盖的止口处加设“O”型密封圈。

5.2 电动机转轴旋转部位采用轴面油封和骨架油封保护。

5.3 电动机的轴承采用密封球轴承或圆柱轴承和平面轴承。

5.4 电动机主体结构见图 1、H160 机座接线盒结构见图 2、H180-200 机座接线盒结构见图 3。

6 防爆要点

6.1 本系列电动机为隔爆型。若电动机内部的可燃易爆性混合物爆炸时，隔爆型电动机外壳不应损坏或产生影响隔爆性能的变形；内部爆炸火焰不允许通过电机的隔爆接合面引起外部爆炸性混合物的爆炸。

6.2 隔爆型电动机的元件（如机座、端盖、轴承内盖、接线盒盖、接线盒座等），精加工后须经压力为 1.5Mpa，加压时间为 10s+2 的静压试验，以不滴水为合格。

6.3 隔爆接合面的长度、间隙、表面粗糙度、接线盒内部裸露导体之间、裸露导体与金属外壳之间的电气间隙及爬电距离应符合 GB/T3836.3-2021 的规定。

6.4 联接隔爆外壳的螺栓均装有弹簧垫圈，防止自行松脱。

6.5 机座、端盖、轴承内盖、接线盒盖、接线盒座、接线螺栓、端子套（或接线板）、轴、橡胶密封圈是隔爆元件。

6.6 在额定工作状态下，电动机外壳表面温度不得超过表 3 的规定。进线口外的温度不得高于所用电缆的允许温度。

表 3

爆炸性混合物级别	T1	T2	T3	T4
电机表面最高允许温度℃	450	300	200	135

7 安装与使用

7.1 电动机的安装应由专业技术人员完成。

7.2 仔细检查电动机外观是否完好、核对电动机铭牌内容是否与实际需求相符。

7.3 隔爆外壳各零部件联接正确，紧固可靠无松动。

7.4 所有隔爆元件应无裂纹或影响隔爆性能的缺陷。

7.5 检查电动机定子绕组绝缘电阻应不低于 20 MΩ。

7.6 安装前应把接线盒等零件从机座上拆下（注意保护隔爆面，引出线顺序）。

7.7 把电动机从上吊入离心机支架内，用螺栓坚固电动机安装平面，按拆卸接线盒等零件的相反顺序装好接线盒等零件。

7.8 联接电动机的电源线，电源线（电缆）不宜过细、过长。

7.9 电缆的外径要与密封圈的孔径相符。使用电缆最小直径为 D1，最大直径为 D5，密封圈材质为橡胶丁腈橡胶，规格及尺寸见表 4（可根据引入电缆外径大小剥去密封圈同心圆）。配合直径差不大于 1mm，当压紧接线头后，应保证密封圈与电缆之间及密封圈与接线盒座之间无间隙，否则将失去隔爆性能。

表 4

机座号	进线方式	密封圈形式	D1	D2	D3	D	b1	b
160	橡套电缆	图 4	Φ20	Φ22.5	-	Φ37 0 -0.1	21	23
180-200			Φ14	Φ20	Φ25	Φ42 0 -0.62	24	26

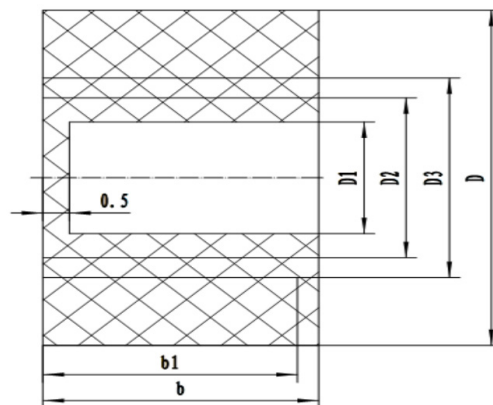

7.10 引入的电缆芯线要接在两弓型垫圈之间，注意芯线的飞刺不要突出，引入接线孔时应防止线芯损伤，引入电缆还须用接线压板和弓形垫圈压紧固定，防止窜动。

7.11 电动机的相序 U（黄色线）、V（黑色线）、W（红色线）须与接入外电源相序 A、B、C 相对应，电动机转向从轴伸端视之为顺时针方向，否则电动机将反转。

7.12 电动机内、外接地螺栓必须可靠接地。

7.13 电动机接好线，经检查确认无误后，方可接通电源进行空载试运转，并观察电机有无异常现象，待空转正常后方可投入负载运行。

7.14 电动机在运行中若发现异常，如怪声、过热、焦味或轴承过热（环境温度不超过 40℃ 时，轴承温度超过 90℃）等，外、内风扇不转等，应立即停机检查，待故障排除后方可使用。

7.15 使用中常见的故障及其可能产生的原因见表 5。

表 5

故障	可能的原因
电动机振动较大	<ol style="list-style-type: none"> 1. 安装不妥 2. 轴弯曲 3. 轴和转鼓的锥度配合不好
电动机不能起动	<ol style="list-style-type: none"> 1. 电源无输出 2. 电动机绕组有断线 3. 过载
电动机虽能起动但不能带负载	<ol style="list-style-type: none"> 1. 过载保护的设定值过低 2. 转子导条或绕组中脱焊或断裂

表 5 (续)

轴承过热	<ol style="list-style-type: none"> 1. 轴承磨损 2. 润滑脂不够 3. 润滑脂过多 4. 轴线未校准 5. 润滑脂硬化
电动机过热	<ol style="list-style-type: none"> 1. 过载 2. 电压太低 3. 电压太高 4. 通风不良
电动机电流过大或跳闸	<ol style="list-style-type: none"> 1. 介质进入电动机内绝缘破坏 2. 过载

注: 对疑难故障, 当采用上述建议无法找到解决办法时, 请向专业技术人员请教或直接与制造厂商联系。

8 保养与维修

8.1 电动机应定期检查和清洁, 外壳不得堆积灰尘, 不得用水龙头喷射清扫电机, 更不能使介质从轴伸端直接进入电动机内(离心机内的介质高度应低于轴伸端口 100mm)。

8.2 电动机运行时轴承允许温度不得超过 95 °C (温度计法), 轴承每运行 2500 小时(约半年)至少检查一次, 如发现轴承润滑脂变质必须及时更换, 更换前, 须将轴承外盖、贮油盒内的废油以及排油装置的油管、油杯清理干净, 并用汽油将轴承清洗干净, 润滑脂推荐采用通用锂基润滑脂 3 号 (GB/T 7324-2010), 加脂量 4 极及以上为 2/3。轴承牌号见表 6。

8.3 拆装电动机时应注意保护隔爆面。拆卸电动机时, 应先拆掉风罩、再拆掉轴伸端的 V 型轴封环, 拆去前端盖、后端盖的固定螺栓, 取下前轴承外盖、前端盖、前轴承、前轴承内盖, 将后端盖连同转子、风扇连体抽出。装配时, 所有隔爆面需涂 204-1 防锈脂。

8.4 电机受潮后, 必须经干燥处理后方可使用。干燥处理可采用烘干或短路电流法。在烘焙过程中, 温度应逐渐升高, 但不可超过 145°C。用短路电流法干燥时, (严重受潮的电机不宜用此方法, 以免发生电解现象。) 电机处于短路状态, 其输入电流为 0.6 ~ 0.8 倍额定电流值为宜。

8.5 更换绕组时, 须记下原绕组的型式、尺寸、线规、匝数。当失落这些数据时, 应向我公司索取。随意改变设计绕组会使电动机某项或几项性能恶化, 以致不能使用。

8.6 防爆零部件维修、更换, 须由专业技术人员按有关技术标准进行维修、验收。

表 6

型 号	轴伸端	非轴伸端 (上) (SAN)	非轴伸端 (下)
YBL160	6211-2RS	6209-2RS	51208
YBL180	6313-2RS	6313-2RS	51310
YBL200	6316-2RS	6315-2RS	51312

9 电动机的贮存及运输

9.1 电机贮存中应保持干燥, 避免周围环境温度急剧变化, 以免电动机受潮、锈蚀。

9.2 贮存中不宜堆积太高, 以免影响通风及损坏下层电动机的包装。

9.3 贮存及运输中电机应侧置放置, 特别要保护轴伸的螺纹和锥度。



图2 H160 接线盒结构



图3 H180-200接线盒结构

We are truly grateful for your purchasing of Wannan Motors. Before using the motor, please scan the QR code to read the manual so as to use and maintain the motor in a right way.

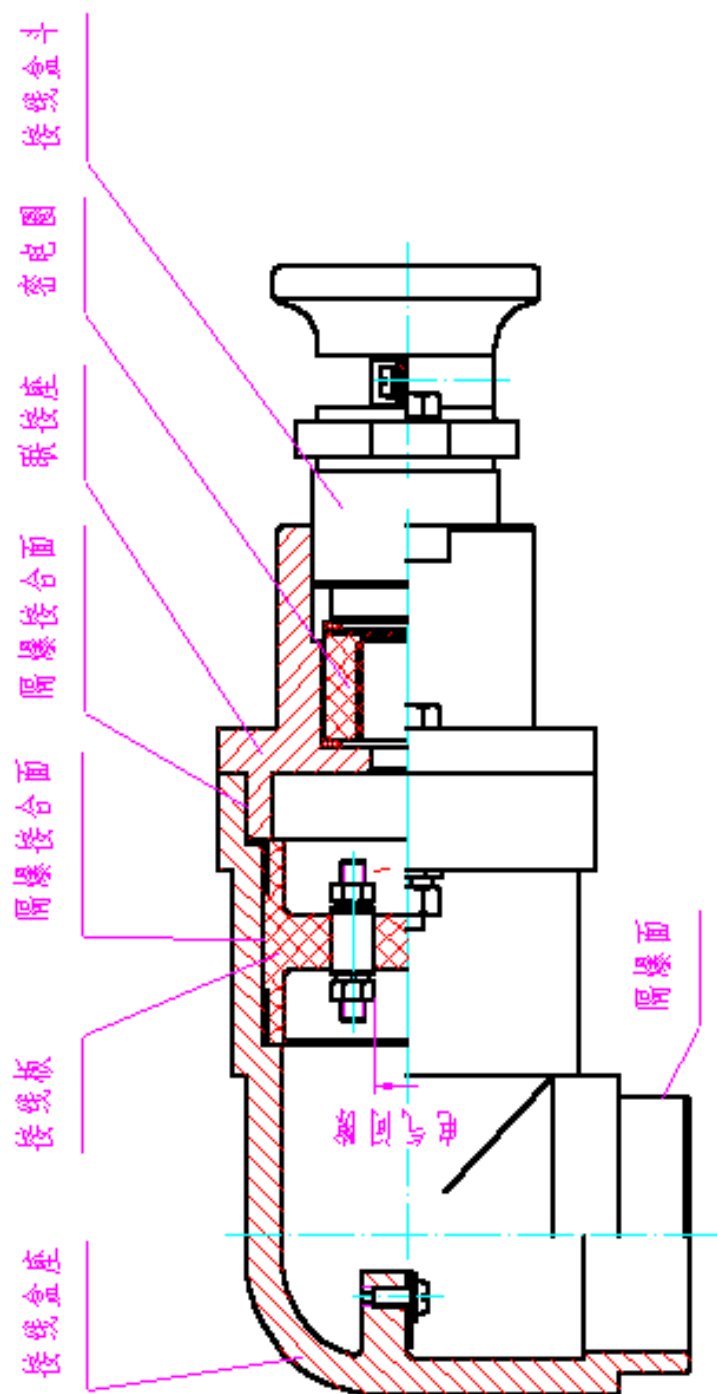
1. Summary

YBL series flameproof three phase asynchronous motors for centrifuge is of totally enclosed, fan-ventilated, squirrel cage type. This series motors are produced in conforming to GB 3836.1-2021 “Electrical equipment used in explosive environment-Part 1: General Requirement” 、 GB3836.2-2021 “Electrical equipment used in explosive environment-Part 2 The Apparatus with the flameproof enclosure ‘d’” With Ex-marking “Ex db II AT4 Gb、 Ex db II BT4 Gb”, this series motors are suitable for workshop where Category II Class A and B flammable gas or the flammable mixture with air and steam of Temperature Group T1~T4 exists in. With the features of high torque, low noise, small size, high capacity and simple mounting, this series motors are ideal for high-speed centrifuge in pharmaceutical factory.

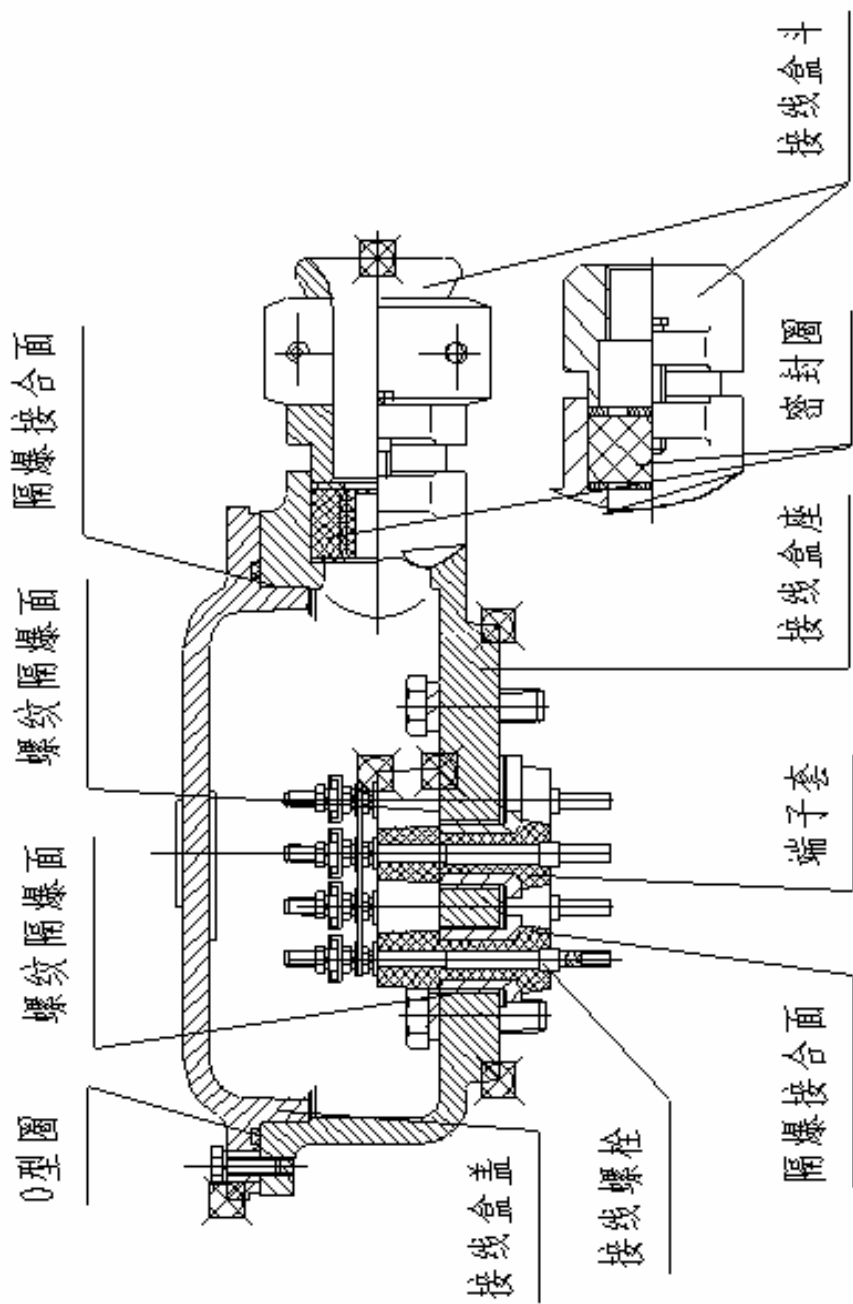
Executive Norm: Q/WN.263—2022 “Specification for flameproof three phase asynchronous motors for centrifuge (frame 160~200)”

2. Designation and types

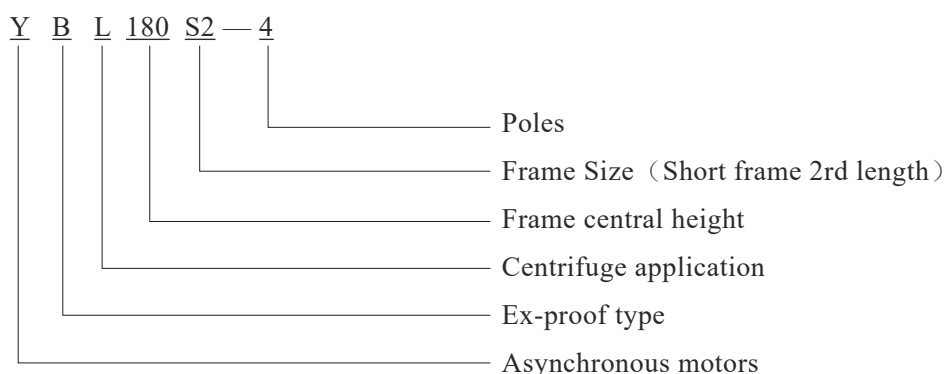

3. Application circumstance

3.1 The applicable common inflammable gas, steam and temperature groups are listed in the table 1 below:

Table 1

Type	Temperature Groups			
	T1	T2	T3	T4
II A	Methane, ethane, propane, styrene, toluene, xylene, carbon monoxide, acetic acid	Butane, propane, ethyl benzene, methanol, ethanol, propyl alcohol, Benzene alcohol	Pentane, hexane, heptane, octane, decane, cyclohexane kerosene, diesel oil, gasoline	
II B	Propine, cyclopropane, coke oven gas	Ethylene, butadiene epoxy ethane, epoxy propane	Dimethylether, propylene aldehyde, hydrogen furfuryl alcohol furan, hydrogen sulfide	ethyl methyl ether, diethyl ether, tetrafluoroethylene

3.2 Operating condition

3.2.1 Not exceed 1000m above the sea level.

3.2.2 Ambient temperature varies as seasonal variation, but the temperature shall not beyond the range -15°C ~+40°C。

3.2.3 The maximum environment relative humidity shall be no more than 90%, besides mean minimum temperature of this month shall be no higher than 25°C .

3.2.4 Motor's rated voltage is 380V, rated frequency 50Hz, F insulation class.

3.2.5 The rating here refers to the continuous rating power on the basis of S1 operation system, the motor allows direct starting.

3.2.6 Maximum temperature of motor casing (by thermometer method) shall be no higher than 130°C even it is working under the most severe condition defined by provision.

3.2.7 Deviation of voltage and frequency from the rating value at the motor running time shall be in accordance with the standard of GB/T 755.

4. Motor technical data and installation type

4.1 Main technical data see table 2

Table 2

Model	Rated Power kW	Rated Voltage V	Rated Voltage A	Rated frequency Hz	Rated speed r/min	Eff %	Power Factor COSΦ
YBL160S1-2	2.2	380	4.8	50	2900	85.0	0.82
YBL160S2-2	3.0	380	6.5	50	2890	85.0	0.82
YBL160S1-4	1.5	380	3.9	50	1445	84.0	0.70
YBL160S2-4	2.2	380	5.5	50	1440	84.0	0.73
YBL160S3-4	3.0	380	7.1	50	1440	85.0	0.76
YBL160S4-4	4.0	380	9.2	50	1430	85.0	0.78
YBL180S-2	4.0	380	8.5	50	2917	87.0	0.82
YBL180S1-4	5.5	380	11.5	50	1415	86.0	0.85
YBL180S2-4	7.5	380	16.2	50	1410	84.0	0.86
YBL180S3-4	11	380	22.3	50	1410	85.0	0.88
YBL180S-6	7.5	380	16.8	50	945	84.0	0.81
YBL200M1-4	11	380	22.6	50	1445	89.0	0.83
YBL200M2-4	15	380	31.0	50	1440	89.0	0.83
YBL200S-6	7.5	380	16.7	50	960	84.0	0.81
YBL200M1-6	11	380	22.6	50	950	87.0	0.85
YBL200M2-6	15	380	32.7	50	905	84.0	0.83
YBL200L1-6	18.5	380	39.9	50	920	82.0	0.87
YBL200L2-6	22	380	46.6	50	920	82.5	0.87

4.2 Motor mounting type IMV16.

5. Subject Structure

5.1 Terminal box, at the top of the motor, has 3 connection terminals. This series motors have 2 kinds of wiring structure: rubber cable (plastic cable) and steel pipe wiring, each with 1 grounding terminal, and be made with 1 (small M5) outlet. Rabbet between terminal box body and its cover shall be fitted with O-sealing ring.

5.2 Motor is fitted with and skeleton oil sealing and shaft surface oil sealing to protect motor shaft rotation part.

5.3 Motor is fitted with sealing ball bearing, cylindrical bearing or plain bearing.

5.4 Subject structure of the motor see figure 1, and the structure of terminal box see figure 2 (H160)、figure 3 (H180-200).

6. Explosion-proof highlight

6.1 The series motor highlights its explosion-proof feature. If the explosive mixture inside the motor explodes, the motor shall not be damaged or deformed to the extent that may affect its explosion-proof performance. The flame inside should not pass through conjunction plane to explode the flammable mixture outside the motor.

6.2 Drilled components of the flameproof motor (such as frame, end cap, bearing inner cover, connection box cover, connection box body etc) should be tested with 1.5Mpa static pressure for 10S+2 and will be checked as qualified only by without dripping during or after the test.

6.3 The length of the flameproof conjunction plane, clearance, roughness of the surface, the creepage distance and electric clearance among bare conductors or between bare conductor and metal casing, all shall be in accordance with GB3836.3-2021.

6.4 Spring washer on fastening bolt can prevent the bolts releasing from flameproof casing.

6.5 Frame, end cover, bearing inner cover, terminal box cover, terminal box body, terminal array (or terminal block), axis fan, shaft, rubber seal ring are all flameproof components.

6.6 Motor casing's max temperature shall follow the stipulation of table 3. Temperature at cable entry shall be no higher than the limit temperature of each cable there-through.

Table 3

Explosive mixture	T1	T2	T3	T4
Motor surface allowable maximum temperature °C	450	300	200	135

7. Installation and usage

7.1 Motor should be installed by technician.

7.2 Check the appearance of the motor to see whether it is in good condition, and check the nameplate to see whether the data is conform to actual requirement.

7.3 Check and guarantee all components are correctly connected and fixed tightly.

7.4 Check and guarantee all flameproof components are without crack or defects affecting explosion-proof performance.

7.5 Measure stator wiring insulation resistance, and the value shall be no less than 20 MΩ.

7.6 Dismantle the components such as terminal box from casing before installation, especially concern about explosion-proof surface and UVW cables marking.

7.7 Lift motor and put motor into centrifuge bracket from top. Fix motor onto plain installation base with bolts. And assemble each components of terminal box.

7.8 Power supply cable shall be neither too long nor too thin.

7.9 External diameter of the cable should fit bore diameter of the seal ring. Cable's min diameter is D1, max is D5; seal ring is made of rubber XH-21, specification and dimension see table 4 (concentric-ring of seal gasket can be striped off to fit inner diameter of lead-in cable). The diameter gap should not exceed 1mm. Clamp the connection plug and ensure that there is no clearance between seal ring and power cable as well as between seal ring and connection box body, otherwise the motor will lose its flameproof function.

Table 4

Frame	Cable	Sealing ring	D1	D2	D3	D	b1	b
160	Rubber-sheathed cable	Fig 4	Φ20	φ22.5	-	Φ37 0 -0.1	21	23
180-200			φ14	φ20	φ25	φ42 0 -0.62	24	26

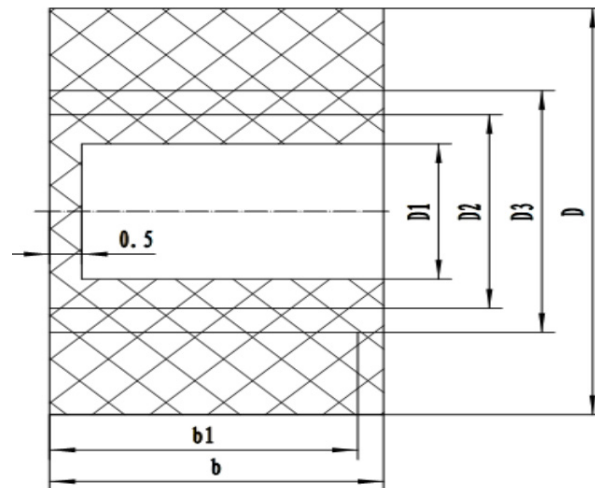

7.10 The cable core shall be attached between arched washers, and thorn on the cable core can't be protruding in case of core damaging when pulling it out through cable entrance. The lead-in cable shall be fixed by connection board and arched washer to avoid movement.

7.11 Motor will rotate clockwise viewed from driving shaft end if the terminals U(yellow cable),V(black cable),W(red cable) are connected respectively to power line A, B, C. Otherwise the motor will rotate anticlockwise.

7.12 Ensure that there is one terminal in the connection box being grounded.

7.13 Correctly connect all wires, turn on power for no-load trial-operation. Only when the motor runs smoothly in the test-running, can it be put into load operation.

7.14 When motor is found to be abnormal, like strange noise, burning smell, fan/blower locked or bearing overheat(bearing temperature exceed 90 when ambient temperature is below 40°C), stop it immediately and have inspection to find causes and solutions.

7.15 The common failures and their solution are listed in table 5

Table 5

Failure	Causes
Severe vibration	<ol style="list-style-type: none"> 1. Improper installation 2. Shaft bending 3. Poor conical degree matching of shaft and rotor.
Start failure	<ol style="list-style-type: none"> 1. Supply power output failure 2. Motor wiring broken 3. Overload
Load-operation failure	<ol style="list-style-type: none"> 1. Overload protection setting too low 2. Rotor conductor bar/wiring broken or welding-off
Bearing overheat	<ol style="list-style-type: none"> 1. Bearing wore 2. Less lubrication grease 3. Much lubrication gerese 4. No calibration for axes 5. Grease hardened
Motor overheat	<ol style="list-style-type: none"> 1. Overload 2. Too low voltage 3. Too high voltage 4. Poor ventilation
High current or tripping	<ol style="list-style-type: none"> 1. Motor insulation broken 2. overload

Note: Contact the manufacture or consult technician when the problems are still unsolved with above methods

8. Maintenance

8.1 Examined and clean the motor periodically, ensure that no dust accumulated on motor casing, spraying with tap for cleaning is not allowed. Guarantee no media will get into motor from drive end (media in centrifuge shall be >100mm lower than shaft end)

8.2 Bearing temperature should not exceed 95 °C (Thermometer method) during operation. The bearing should be inspected every 2500h (about half a year) operation. The bearing grease should be replaced immediately if the grease is found to be spoiled (Sealed bearing need not replace its lubrication grease in its lifetime). But the waste grease in bearing internal/external cover, oil chamber, oil tube, oil nipple must be cleaned out. No.3 general lithium lubricating grease (GB/T 7324-2010) is recommended to fill 2/3 of the grease chamber. Bearing size see attachment 6.

8.3 Not damage flameproof conjunction surface when dismantling motor. The steps are: firstly remove fan cover, and V-seal ring on the drive end, secondly remove the bolts on front and rear end cover, and lastly take out the rotor together with the front end cover and cooling fan. All flameproof conjunction surface shall be coated with 204-1 anti-rust grease.

8.4 Motor must be dried before use if it has been affected with damp by means of drying in the oven or short-circuit current. The temperature should be increased gradually but not exceed 145°C when dried in the oven. And when the motor dried by short-circuit method, it should be connected as short circuit whose input current is 0.6-0.8 time rated current. However the short-circuit method is not suitable for the motor which is heavily damped, since it may damage winding's performance.

8.5 If the winding needs to be replaced, the original winding's type, dimensions, diameter and turns of coil should be recorded. Arbitrarily changing of winding will decrease the performance of the motor, and even to damage the motor.

8.6 Maintenance or replacement of its components must be done by professional worker.

Table 6

Model	DE bearing	NDE bearing(up)(SAN)	NDE bearing (down)
YBL160	6211-2RS	6209-2RS	51208
YBL180	6313-2RS	6313-2RS	51310
YBL200	6316-2RS	6315-2RS	51312

9. Storage and transportation

9.1 Select dry and clean environment where huge temperature change will not happen for motor storage. And protect motor from the dampness and rust.

9.2 Motor can't be packed to high since poor ventilation will damage its insulation.

9.3 Sided storage is recommended, especially protect motor drive end's thread and tape.



图 2 H160 接线盒结构
Fig2 H160 Terminal box structure



图3 H180-200接线盒结构

Fig 3 H180-200 Terminal box structure

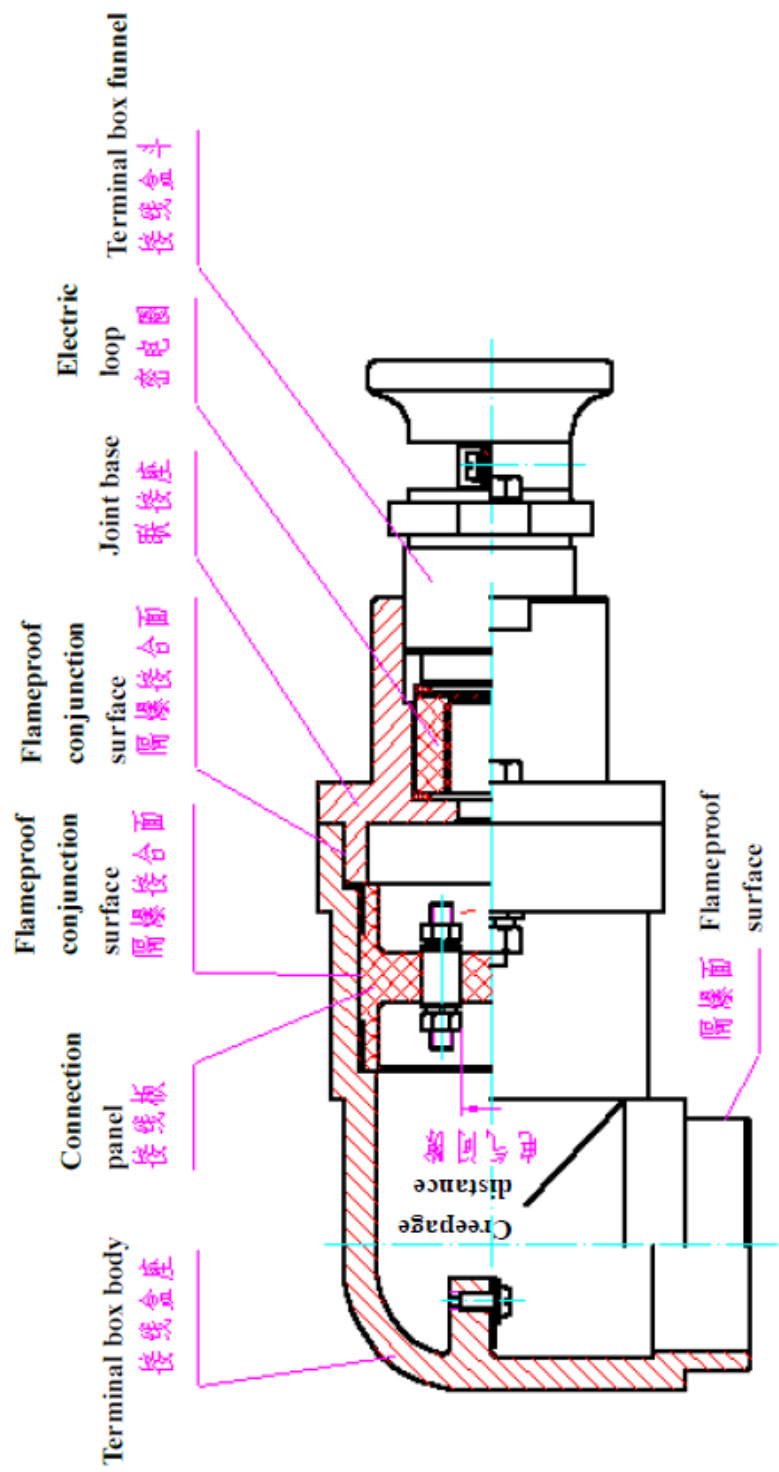
敬告用户：

请您按照本使用说明书的规定，正确地使用和储存电动机，我们将为您提供优质、快捷的服务。

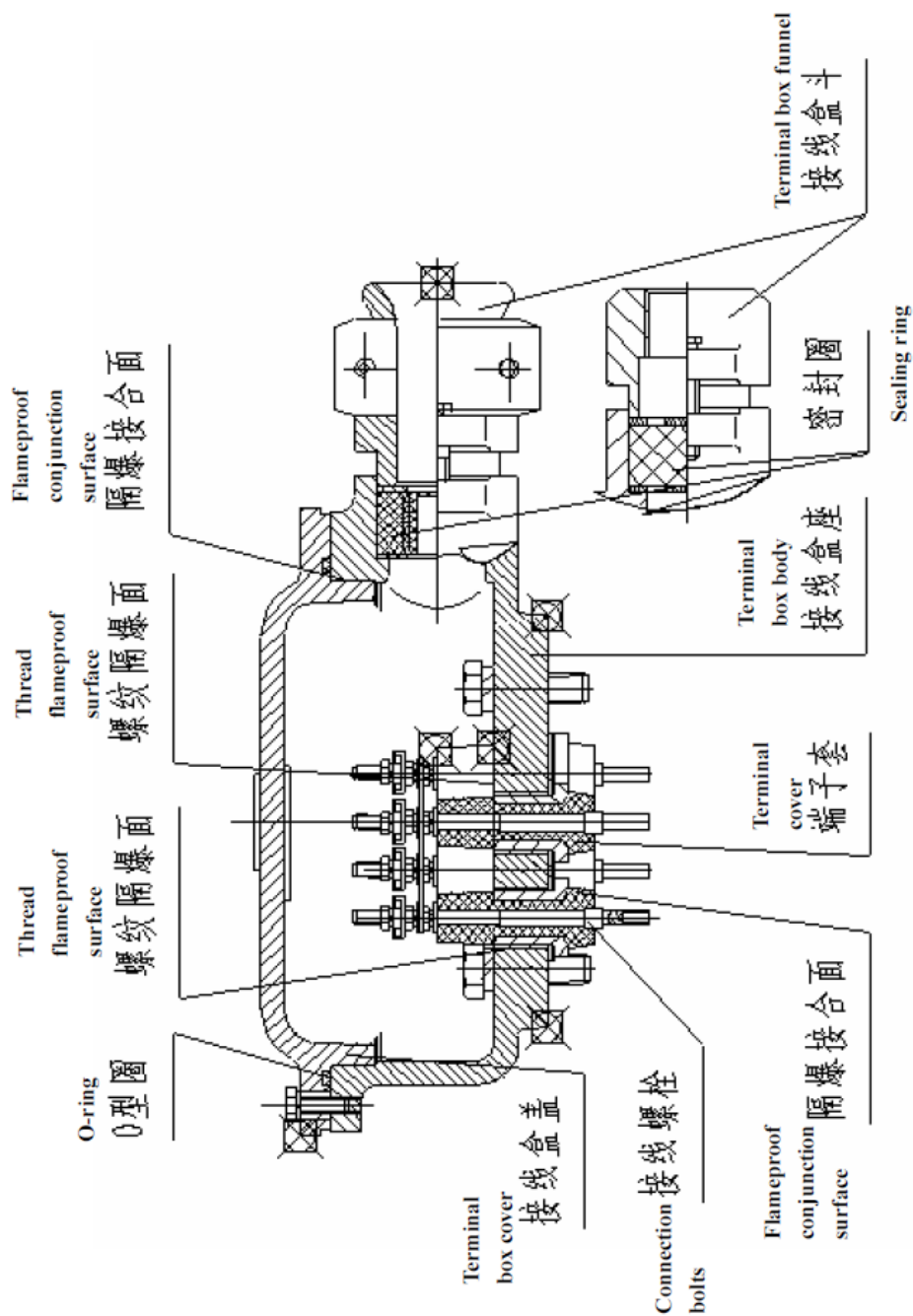
在电动机使用过程中，您如有什么疑惑请与我们联系，我们将及时给予您满意的解答；您有什么良好的建议请向我们提出，以便我们改进，为您提供优质、快捷的服务。

安徽皖南电机股份有限公司对本使用说明书保留最终解释权。

请勿在未事先获得安徽皖南电机股份有限公司书面许可的情况下向第三方复制、公布或者使用本使用说明书内容。

Dear user,

Please use and store the motor right following the instruction of the manual. We will make our effort to provide you with high-quality and prompt service. Contact us if you had any questions in application, and we will offer you timely and effective resolution; let us know if you had any advices or suggestions, with which we can improve ourselves and make service better. Anhui Wannan Motor Co., Ltd. reserves the right of final interpretation of the user manual. No copy, disclosing or using of the content of this user manual to third parties prior to written permission from Anhui Wannan Motor Co., Ltd.

安徽皖南电机股份有限公司

Anhui Wannan Electric Machine Co.,Ltd

地址：安徽省泾县泾川镇南华路 86 号

Address: No.86 Nanhua Road Jingxian County Anhui Province P.R.C

销售处 **Sales department:** 400-111-0563 0563-5031908 5031988

客户服务中心 **Customer service center:** 0563-5031953

企业管理处 **Enterprises management department:** 0563-5031954

质量检验处 **Quality inspection department:** 0563-5031910 5031985

传真 **Fax:** (0563) 5029999 5023698

网址 **Website:** <http://www.wnmotor.com>

E-mail: wndjc@wnmotor.com

邮编 **Postal code:** 242500

本说明书内容如有变动，恕不另行通知。

Content in the manual may be changed without prior notice.